

HJT PV MODULE INSTALLATION MANUAL

1. General Information
 - 1.1 Overview
 - 1.2 Installation Manual Disclaimer
 - 1.3 Limitation of Liability
 - 1.4 Fire Safety
2. Installation
 - 2.1 Installation Safety
 - 2.2 Installation Condition
 - 2.3 Mechanical Installation Introduction
3. Module Wiring
 - 3.1 Correct Wiring Scheme
 - 3.2 Correct Connection of Plug Connectors
4. Maintenance and Care
 - 4.1 Visual Inspection
 - 4.2 Module Cleaning
 - 4.3 Inspection of Connector and Cable
5. Electrical Specification
 - 5.1 Test Conditions
 - 5.2 Electrical Installation

ANHUI HUASUN ENERGY CO.,LTD.

Address: No.99, Qingliu Road, Xuancheng Economic Development Zone, 242000, Xuancheng City, Anhui, China.

Tel: +86-563-2626509 Email: sales@HUASUNSolar.com

All rights reserved © 2022 Rev.1.0 HUASUN Energy

1. General Information

1.1 Overview

This general manual provides important safety information relating to the installation, maintenance and handling of heterojunction(HJT) solar modules. Professional installer must read these guidelines carefully and strictly follow these instructions. Failure to follow these instructions may result in death, injury or property damage. The installation and handling of HJT PV modules requires professional skills and should only be performed by qualified professionals. Installers must inform end-users (consumers) about the aforesaid information accordingly.

The "module" or "HJT module" in this specification refers to one or more HS series HJT photovoltaic modules. Please keep this manual for future reference.

It is recommended to visit the HUASUN website www.HUASUNSolar.com regularly to obtain the latest version.

1.2 Installation Manual Disclaimer

Because the use of the manual and the conditions or methods of installation, operation, use and maintenance of photovoltaic (PV) product are beyond HUASUN's control, HUASUN does not accept responsibility and expressly disclaims liability for loss ,damage, or expense arising out of or in any way connected with such installation, operation, use or maintenance. No responsibility is assumed by HUASUN for any infringement of patents or other rights of third parties, which may result from use of the PV product. NO license is granted by implication or otherwise under any patent or patent rights.

The information in this manual is based on HUASUN's knowledge and experience and is believed to be reliable, but such information including product specification (without limitations) and suggestions do not constitute a warranty, expresses or implied. HUASUN reserve the right to change the manual, the PV produce, the specifications, or product information sheets without prior notice.

1.3 Limitation of Liability

ANHUI HUASUN ENERGY CO.,LTD.

Address: No.99, Qingliu Road, Xuancheng Economic Development Zone, 242000, Xuancheng City, Anhui, China.

Tel: +86-563-2626509 Email: sales@HUASUNSolar.com

All rights reserved © 2022 Rev.1.0 HUASUN Energy

HUASUN is not responsible for any form of injury, including but not limited to module operation, system installation, and physical injury, injury and property damage caused by whether it is in accordance with the instructions in this manual.

1.4 Fire Safety

Please refer to local laws and regulations before installing modules and abide by requirements on building fire protection. According to the corresponding certification standards, the fire rating of HUASUN modules is Class C (According to UL790).

The roof should be coated by a layer of fireproof materials with suitable fire protection rating for roofing installation and make sure that the back sheet and the mounting surface are fully ventilated.

Different roof structures and installation modes will affect fireproof performance of buildings. Improper installation may lead to the risk of fire.

To guarantee roof fire rating, the distance between module frame and roof surface must be $\geq 10\text{cm}$. (4in)

Adopt proper module accessories such as fuse, circuit breaker and grounding connector according to local regulations.

Please do not apply modules in where exposed inflammable gases are nearby.

2. Installation

2.1 Installation Safety

- 1) Always wear protective head gear, insulating gloves and safety shoes (with rubber soles).
- 2) Never disconnect electrical connections or unplug connectors while the circuit is under load.
- 3) Contact with electrically active parts of the modules, such as terminals, can result in burns, sparks and lethal shock whether or not the module is connected.
- 4) Do not touch the PV module unnecessarily during installation. The glass surface and

ANHUI HUASUN ENERGY CO.,LTD.

Address: No.99, Qingliu Road, Xuancheng Economic Development Zone, 242000, Xuancheng City, Anhui, China.

Tel: +86-563-2626509 Email: sales@HUASUNSolar.com

All rights reserved © 2022 Rev.1.0 HUASUN Energy

the frame may be hot; there is a risk of burns and electric shock.

- 5) Do not work in the rain, snow or in windy conditions.
- 6) Avoid exposing cables and connectors to direct sunlight and scratches or cuts in order to prevent insulation degradation.
- 7) Use only insulated tools that are approved for working on electrical installations.
- 8) Keep children well away from the system while transporting and installing mechanical and electrical components.
- 9) Completely cover the module with an opaque material during installation to prevent electricity from being generated.
- 10) Do not wear metallic rings, watchbands, earrings, nose rings, lip rings or other metallic objects while installing or troubleshooting photovoltaic systems.
- 11) Follow the safety regulations(e.g., safety rules for working on electrical power plant stations) of your regions and for all other system components, including wires and cables, connectors, charging regulators, inverters, storage batteries, rechargeable batteries, etc.
- 12) Under normal conditions, a photovoltaic module is likely to experience conditions that produce more current and/or voltage than reported at standard test conditions. Accordingly, the values of I_{sc} and V_{oc} marked on this module should be multiplied by a factor of 1.25 when determining component voltage ratings, conductor current ratings, minimum factor of fuse sizes, and size of controls connected to the PV output.
- 13) Only use same connectors to connect modules to form a string, or connect to another device. Removing the connectors will void the warranty.

2.2 Installation Conditions

2.2.1 Climate Conditions

Please install the modules in the following conditions:

- a) Working environment: -40°C to $+40^{\circ}\text{C}$
- b) Humidity: $< 85\text{RH}\%$

* Note: The mechanical load bearing (include wind and snow loads) of the module is based

ANHUI HUASUN ENERGY CO.,LTD.

Address: No.99, Qingliu Road, Xuancheng Economic Development Zone, 242000, Xuancheng City, Anhui, China.

Tel: +86-563-2626509 Email: sales@HUASUNSolar.com

All rights reserved © 2022 Rev.1.0 HUASUN Energy

on the installation method and installation location. When calculating the mechanical load, a professional installer must calculate it according to the design requirements of the system. Modules should be installed in locations where the altitude is less than 2000m.

2.2.2 Site Selection

- The modules should be facing south in northern latitudes and north in southern latitudes. HUASUN recommends that the inclination angle of the installation modules should not be less than 10°, so that the dust is washed away by rain, and more effective light intensity and ventilation are obtained, because the hot air above and below the components can flow in one direction and the components are efficient at lower temperatures higher.
- For detailed information about the best installation angle, please refer to the standard solar photovoltaic installation guide or consult professional solar installers and system integrators.

- The modules should not be blocked by sunlight at any time.
- Do not use components near or in locations where flammable gas may be generated or collected.
- The modules cannot be directly irradiated by artificially concentrated sunlight.

2.3 Mechanical Installation Introduction

HJT PV modules usually can be installed in the following ways: Clamps and Bolts.

Note:

- 1) All installation methods herein are for reference only, and HUASUN is not responsible for providing related installation parts, design and installation of modules systems. Mechanical load and safety must be completed by a professional system installer or an experienced person.
- 2) Before installation, you need to confirm the following important items:
 - a) Visually check the module for any damage. Clean the module if any dirt or residue remains from shipping.
 - b) Check if the serial number of the module is correct.

ANHUI HUASUN ENERGY CO.,LTD.

Address: No.99, Qingliu Road, Xuancheng Economic Development Zone, 242000, Xuancheng City, Anhui, China.

Tel: +86-563-2626509 Email: sales@HUASUNSolar.com

All rights reserved © 2022 Rev.1.0 HUASUN Energy

3) The mechanical load of HUASUN HJT PV modules (framed module) was tested under 5400Pa on the front side (Designed 3600Pa, safety factor 1.5) and 2400Pa on the back side (Designed 1600Pa, safety factor 1.5). PV modules (frameless module) was tested under 3600Pa on the front side (Designed 2400Pa, safety factor 1.5) and 2400Pa on the back side (Designed 1600Pa, safety factor 1.5). If the installation environment of the module is snowy and strong wind, special protection should be adopted when the module is installed to meet the actual requirements.

2.3.1 Mounting with Clamps (framed module)

The module clamps used with M8 bolts should not contact with the front glass and not deform the frame. Be sure to avoid shadowing effects from the module clamps. The module frame is not to be modified under any circumstances. When choosing the type of clamp-mounting method, please make sure that there are four clamps on each module, two clamps should be attached on each long sides of the module.

Depending on the local wind and snow loads, if excessive pressure load is expected, additional clamps or support would be required to ensure the module can bear the load. The torque used for installation is 16-20N.

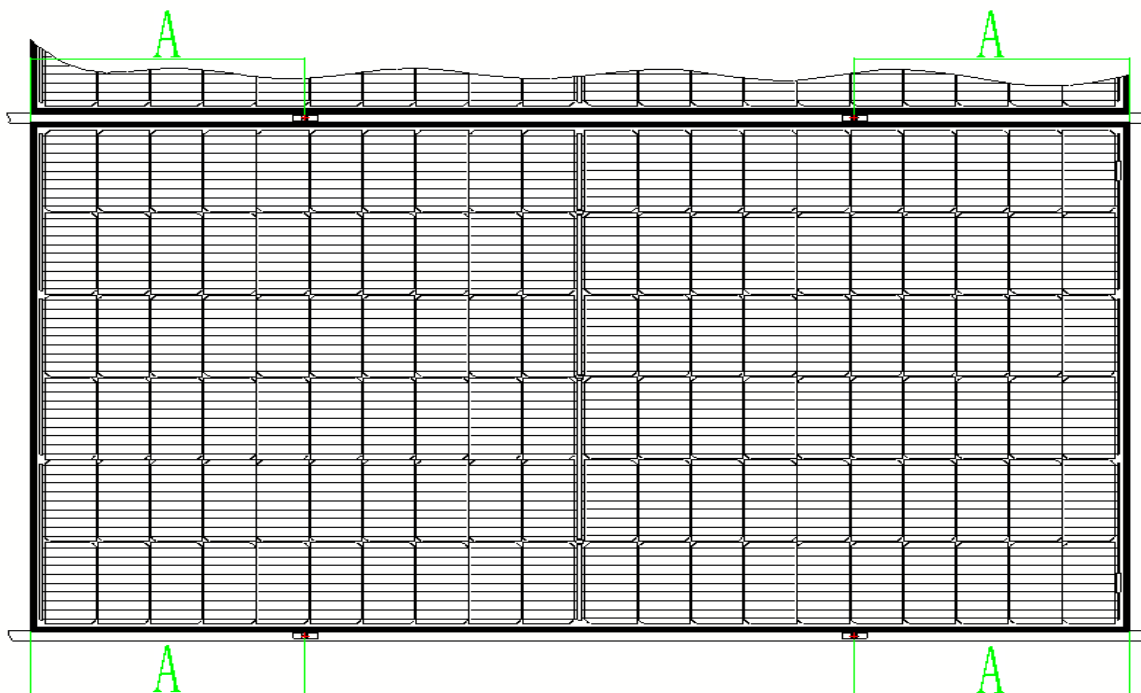

ANHUI HUASUN ENERGY CO.,LTD.

Address: No.99, Qingliu Road, Xuancheng Economic Development Zone, 242000, Xuancheng City, Anhui, China.

Tel: +86-563-2626509 Email: sales@HUASUNSolar.com

All rights reserved © 2022 Rev.1.0 HUASUN Energy

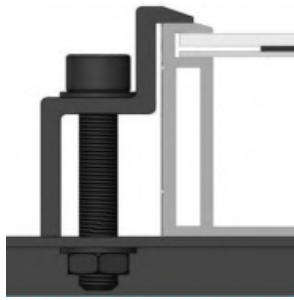

Fringe Modules Installation

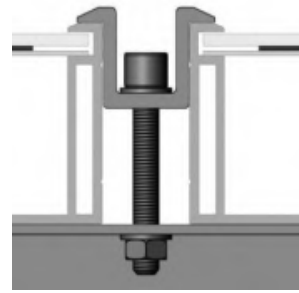

Middle Modules Installation

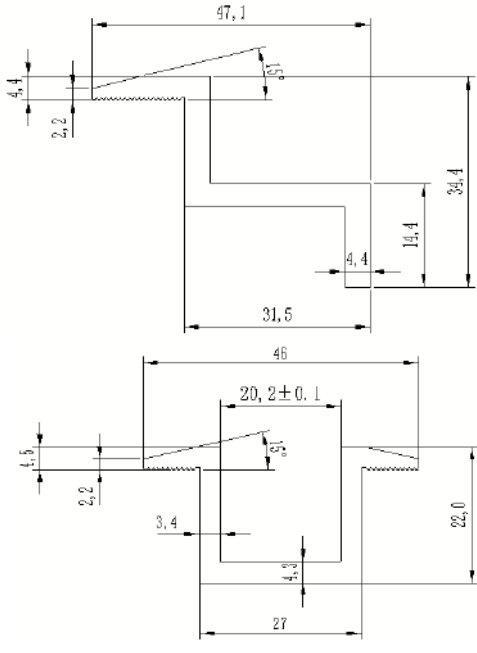
Module Type	A	Clamp Length	Clamp Type (for reference)
HS-B120DS HS-B120DSN HS-B120DSB HS-S120SS HS-S120SSB HS-S120DSB HS-B96DSN	439±50mm	60mm	
HS-B132DS HS-B132DSN HS-B132DSB HS-S132SS HS-S132SSB	485±50mm	60mm	
HS-B144DS HS-B144DSN HS-B144DSB HS-S144SS HS-S144SSB	525±50mm	60mm	
HS-B156DS HS-B156DSN HS-B156DSB HS-S156SS HS-S156SSB	567±50mm	60mm	
HS-210-B110DS	440~540mm	60mm	
HS-210-B120DS	360~430mm	60mm	
HS-210-B132DS	440~540mm	60mm	

2.3.2 Mounting with Clamps (frameless module)

ANHUI HUASUN ENERGY CO.,LTD.

Address: No.99, Qingliu Road, Xuancheng Economic Development Zone, 242000, Xuancheng City, Anhui, China.

Tel: +86-563-2626509 Email: sales@HUASUNSolar.com

All rights reserved © 2022 Rev.1.0 HUASUN Energy

The module clamps used with M8 bolts should not make glass winding. Be sure to avoid shadowing effects from the module clamps. When choosing the type of clamp-mounting method, please make sure that there are six clamps on each module, three clamps should be attached on each long sides of the module.

Depending on the local wind and snow loads, if excessive pressure load is expected, additional clamps or support would be required to ensure the module can bear the load.

The torque used for installation is 16-20N.

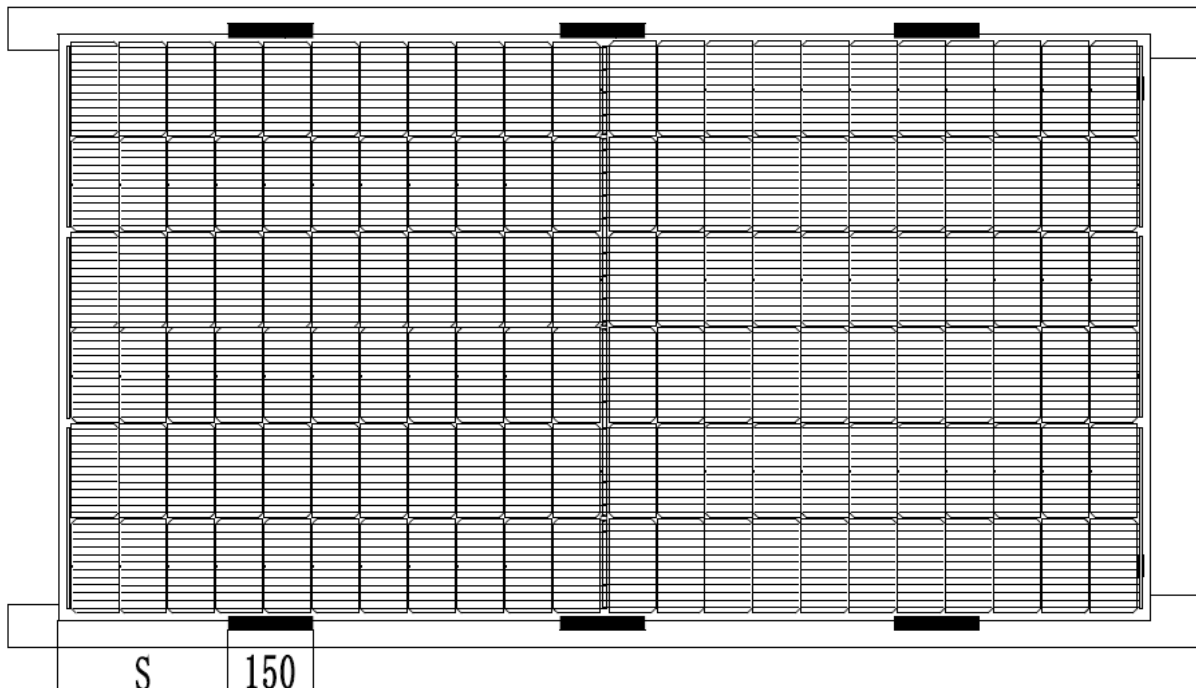

ANHUI HUASUN ENERGY CO.,LTD.

Address: No.99, Qingliu Road, Xuancheng Economic Development Zone, 242000, Xuancheng City, Anhui, China.

Tel: +86-563-2626509 Email: sales@HUASUNSolar.com

All rights reserved © 2022 Rev.1.0 HUASUN Energy

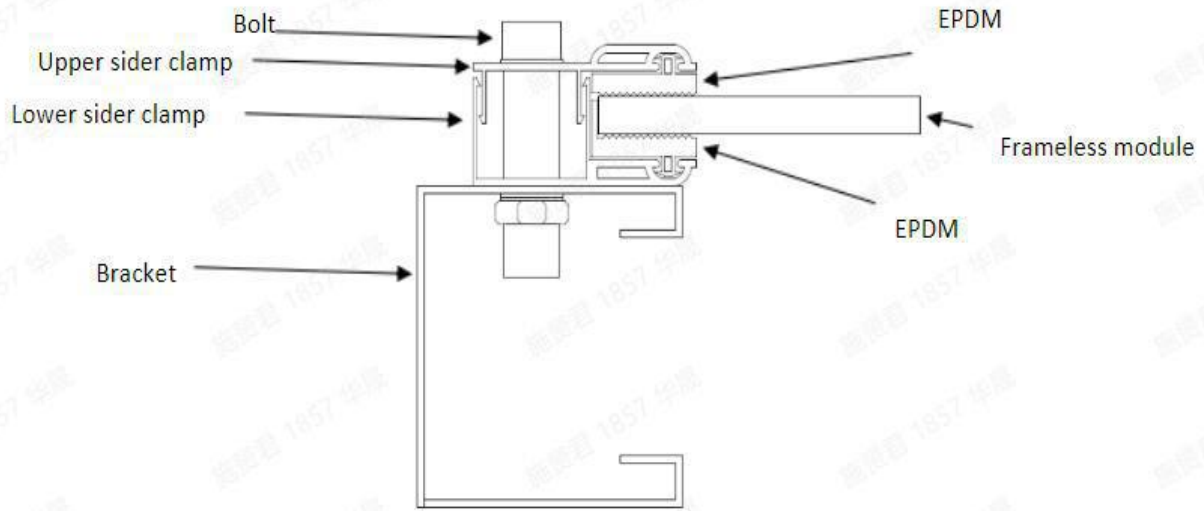

Module Type	S	Clamp Length
HS-B120DN HS-B120DNN	300~400mm	150mm
HS-B132DN HS-B132DNN	300~400mm	150mm
HS-B144DN HS-B144DNN	400~500mm	150mm
HS-B96DNN	200~300mm	150mm

2.3.3 Mounting with Bolts (framed module)

There are 4 or 8 mounting holes of 9mm*14mm and 7mm*10mm on the frame of the module. In consideration of the fastness of the module after installation, each mounting hole must be fixed with the corresponding bolt connection.

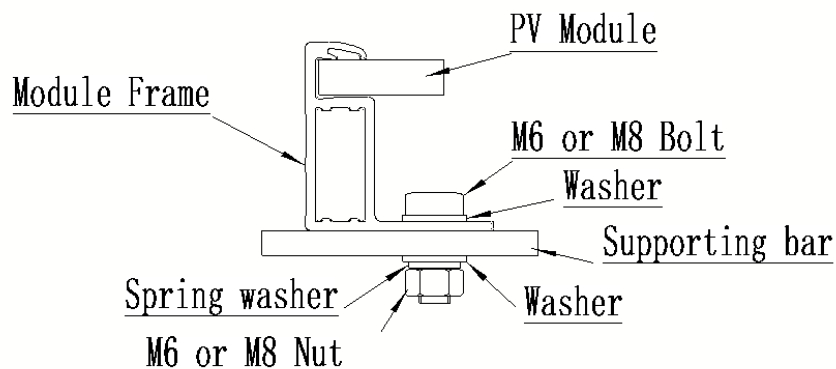

ANHUI HUASUN ENERGY CO.,LTD.

Address: No.99, Qingliu Road, Xuancheng Economic Development Zone, 242000, Xuancheng City, Anhui, China.

Tel: +86-563-2626509 Email: sales@HUASUNSolar.com

All rights reserved © 2022 Rev.1.0 HUASUN Energy

Module Type	Bolt Type	Quantity
HS-B120DS HS-B120DSN HS-B120DSB HS-S120SS HS-S120SSB HS-S120DSB HS-B96DSN	M8	4 sets
HS-B132DS HS-B132DSN HS-B132DSB HS-S132SS HS-S132SSB HS-B144DS HS-B144DSN HS-B144DSB HS-S144SS HS-S144SSB HS-B156DS HS-B156DSN HS-B156DSB HS-S156SS HS-S156SSB HS-210-B110DS HS-210-B120DS HS-210-B132DS	M6 & M8	4 sets/each

3. Module Wiring

3.1 Correct Wiring Scheme

- ① Ensure that the wiring is correct before starting up the system. If the measured open circuit voltage (Voc) and short-circuit current (Isc) differ substantially from the specifications, this indicates that there is a wiring fault.
- ② Do not connect different connectors (brand and model) together.
- ③ Before the modules are connected to the grid, appropriate protective measures need to be taken to prevent water vapor and dust from penetrating into the connector.

ANHUI HUASUN ENERGY CO.,LTD.

Address: No.99, Qingliu Road, Xuancheng Economic Development Zone, 242000, Xuancheng City, Anhui, China.

Tel: +86-563-2626509 Email: sales@HUASUNSolar.com

All rights reserved © 2022 Rev.1.0 HUASUN Energy

- ④ The cable should be fixed on the module frame or mounting rail to avoid blocking the back of the module.
- ⑤ In order to meet the system wiring requirements, the distance between the two adjacent modules of the left and right must be within 50mm; for the adjacent two rows of modules, the distance between the modules must be within 25mm.

3.2 Correct Connection of Plug Connectors

- Make sure that all connections are safe and properly mated. The PV connectors should not be subjected to stress from the exterior. Connectors should only be used to connect the circuit. They should never be used to turn the circuit on and off.
- If the connector is not connected positively and negatively, the connector is not waterproof. After the modules are installed, they need to be connected as soon as possible or take appropriate measures (such as using connector end caps) to avoid infiltration of water vapor and dust.
- Do not clean or precondition the connectors using lubricants or any unauthorized chemical substances.

4. Maintenance and Care

It is required to perform regular inspection and maintenance of the modules, especially during the warranty period. In order to ensure the best performance of the modules, HUASUN recommends the following maintenance measures:

4.1 Visual Inspection

Please carefully check the modules for appearance defects. Focus on the following points:

- a) If modules are observed having slight cell color differences at different angles, this is a normal phenomenon of modules with anti-reflection coating technology;
- b) Whether the glass is broken;
- c) Whether any sharp objects touch the surface of the module;

ANHUI HUASUN ENERGY CO.,LTD.

Address: No.99, Qingliu Road, Xuancheng Economic Development Zone, 242000, Xuancheng City, Anhui, China.

Tel: +86-563-2626509 Email: sales@HUASUNSolar.com

All rights reserved © 2022 Rev.1.0 HUASUN Energy

- d) Whether the module is blocked by obstacles or foreign objects; if there is snow, you can use a brush with soft bristles to clean the surface of the module;
- e) Whether there is corrosion near the grid line of the cell. This kind of corrosion is caused by the damage of the packaging material on the surface of the module during installation or transportation, which causes water vapor to penetrate into the module;
- f) Observe whether there are burn-through traces on the back plate of the module;
- g) Check whether the fixing screws between the modules and the bracket are loose or damaged, and adjust or repair them in time;
- h) The system should be checked regularly to ensure that the supporting structure of the junction box is intact;
- I) If you need inspection or maintenance of electrical or mechanical performance, it is recommended that the inspection or maintenance be carried out by certified and approved professionals to avoid electric shock or personal injury.

4.2 Module Cleaning

4.2.1 Safety Warning

- Cleaning will cause the risk of damage to modules and a series of parts, and also increase the risk of electric shock.
- Cracked or damaged modules will present a risk of electric shock due to leakage current, and wet modules will aggravate this risk of electric shock. Before cleaning, check the modules for cracks, damage, and loose joints.
- During the day, the voltage and current existing in the array are enough to cause fatal electric shock accidents.
- Since touching exposed parts of live parts can cause injury, make sure that the circuit is disconnected before cleaning.
- Before cleaning, make sure that the array and live parts (such as inverters and combiner boxes) are disconnected.
- Wear suitable protective clothing (clothes, insulating gloves, etc.).
- Do not immerse the modules partially or completely in water or any kind of washing liquid.

ANHUI HUASUN ENERGY CO.,LTD.

Address: No.99, Qingliu Road, Xuancheng Economic Development Zone, 242000, Xuancheng City, Anhui, China.

Tel: +86-563-2626509 Email: sales@HUASUNSolar.com

All rights reserved © 2022 Rev.1.0 HUASUN Energy

4.2.2 Handling Notice

- Use a proper cleaning solution and suitable cleaning equipment.
- Do not use abrasive or electric cleaners on the module.
- Particular attention should be taken to avoid the module back-sheet or frame to come in contact with sharp objects, as scratches may directly affect product safety.
- Do not use abrasive cleaners, degreasers or any unauthorized chemical substance (e.g. oil, lubricant, pesticide, etc.) on the module.
- Do not use cleaning corrosive solutions containing hydrofluoric acid, alkali, acetone, or industrial alcohol. Only substances explicitly approved by HUASUN are allowed to be used for cleaning modules.
- HUASUN recommends to avoid rotating brush cleaning methods, as they could create micro-cracks in the PV modules.
- Dirt must never be scraped or rubbed away when dry, as this will cause micro-scratches on the glass surface

4.3 Inspection of Connector and Cable

The following preventive maintenance is recommended every six months:

- a) Check the sealing gels of the junction box for any damage.
- b) Examine the PV module(s) for signs of deterioration. Check all wiring for possible rodent damage, weathering and that all connections are tight and corrosion free. Check electrical leakage to ground.

5. Electrical Specification

5.1 Test conditions

The module electrical rating are measured under two Standard Test Conditions, In some cases, the module may generate a voltage or current value higher or lower than the rated value. The maximum allowable reflected light intensity on the back is 300W/m².

For detailed electrical parameters under these two test conditions please refer to modules

ANHUI HUASUN ENERGY CO.,LTD.

Address: No.99, Qingliu Road, Xuancheng Economic Development Zone, 242000, Xuancheng City, Anhui, China.

Tel: +86-563-2626509 Email: sales@HUASUNSolar.com

All rights reserved © 2022 Rev.1.0 HUASUN Energy

datasheet.

5.1.1 1000W/m² on front, irradiance with AM 1.5 spectrum and 25°C (77°F) ambient temperature, hereinafter referred to as STC.

5.1.2 1000W/m² on front, 135W/m² on back, irradiance with AM 1.5 spectrum and 25°C (77°F) ambient temperature, hereinafter referred to as BSTC.

5.2 Electrical Installation

The maximum allowed quantity of modules in string connection shall be calculated according to relative regulations. The open circuit voltage value under the expected lowest temperature shall not exceed the maximum system voltage value allowed by modules and other values required by DC electric parts.

Normally, the Voc factor can be calculated by the following formula. $C_{Voc}=1-\beta V_{oc} \times (25-T)$

T: The expected lowest temperature of the installation site.

β : Voc temperature coefficient (%/°C) (Refer to modules datasheet)

Recommended maximum series is $[\text{Max System voltage } V / (1.25 * V_{oc})]$, parallel module configurations is $[\text{fuse rating} / 1.25 * I_{sc}]$